



www.alfatronelectronics.com

ALFATRON ELECTRONICS GmbH GERMANY

ALF-SMW42S

**4x2 Seamless Wireless Switcher
with Multi-View 4K 60Hz 4:4:4**

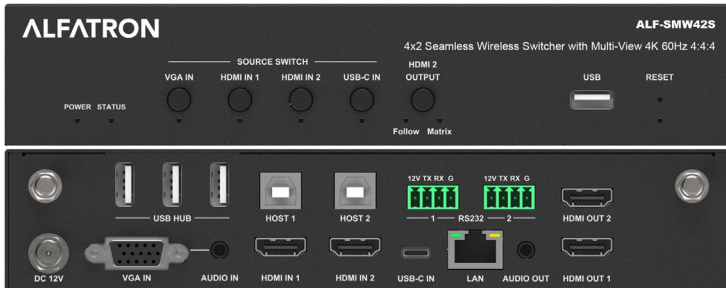

All Rights Reserved



FCC Statement

Changes or modifications not expressly approved by the party responsible for compliance could void the user's authority to operate the equipment.

This equipment has been tested and found to comply with the limits for a Class B digital device, pursuant to Part 15 of the FCC Rules. These limits are designed to provide reasonable protection against harmful interference in a residential installation. This equipment generates uses and can radiate radio frequency energy and, if not installed and used in accordance with the instructions, may cause harmful interference to radio communications.

However, there is no guarantee that interference will not occur in a particular installation. If this equipment does cause harmful interference to radio or television reception, which can be determined by turning the equipment off and on, the user is encouraged to try to correct the interference by one or more of the following measures:

- Reorient or relocate the receiving antenna.
- Increase the separation between the equipment and receiver.
- Connect the equipment into an outlet on a circuit different from that to which the receiver is connected.
- Consult the dealer or an experienced radio/TV technician for help

This device complies with part 15 of the FCC rules. Operation is subject to the following two conditions (1) this device may not cause harmful interference, and (2) this device must accept any interference received, including interference that may cause undesired operation and after change.

Radiation Exposure

This equipment complies with FCC radiation exposure limits set forth for an uncontrolled environment.

This device complies with Industry Canada license-exempt RSS standard(s). Operation is subject to the following two conditions:

- (1) this device may not cause interference, and
- (2) this device must accept any interference, including interference that may cause undesired operation of the device.

"Le présent appareil est conforme aux CNR d'Industrie Canada applicables aux appareils radio exempts de licence. L'exploitation est autorisée aux deux conditions suivantes :

- (1) l'appareil ne doit pas produire de brouillage, et
- (2) l'utilisateur de l'appareil doit accepter tout brouillage radioélectrique subi, même si le brouillage est susceptible d'en compromettre le fonctionnement."

Radiation Exposure:

This equipment complies with IC radiation exposure limits set forth for an uncontrolled environment.

Déclaration d'exposition aux radiations: Cet équipement est conforme aux limites d'exposition aux rayonnements IC établies pour un environnement non contrôlé.

All RF frequencies are not restricted in EU member states.



Do not dispose of this product with the normal household waste at the end of its life cycle. Return it to a collection point for the recycling of electrical and electronic devices. This is indicated by the symbol on the product, user manual or packaging. The materials are reusable according to their markings. By reusing, recycling or other forms of utilisation of old devices you make an important contribution to the protection of our environment. Please contact your local authorities for details about collection points.

Preface

1. Read, follow, and keep these instructions.
2. Heed all warnings.
3. Do not use this product near water. Keep away from wet places, such as: spas, pools, sinks, laundries, wet basements, etc.
4. When cleaning, unplug the device and wipe with a dry cloth. Do not use damp cloths, cleaning fluids, or aerosols which may result in electric shock, fire, or switcher damage.
5. Operate this product using only the included power supply and/or power cable. Use of an unapproved power implement may impair performance, damage the product, or cause fires.
6. Do not block any ventilation openings. Install in accordance with the manufacturer's instructions.
7. Do not install or place this product near any heat sources such as radiators, heat registers, stoves, or other apparatus (including amplifiers) that produce heat.
8. Protect the power cord from being walked on or pinched particularly at plugs, convenience receptacles, and the point where they exit from the product.
9. Only use attachments/accessories specified by Alfatron to avoid fire, shock, or other hazards.
10. To reduce the risk of electric shock and/or damage to this product, never handle or touch this device or power cord if your hands are damp or wet. Do not expose this product to liquids or moisture.
11. Unplug this product during lightning storms or when unused for long periods of time.
12. Never open, remove device panels, or make any adjustments not described in this manual. Attempting to do so could result in electric shock, damage to the device, or other hazards.



The lightning flash with arrowhead symbol, within an equilateral triangle, is intended to alert the user to the presence of uninsulated dangerous voltage within the product's enclosure that may be of sufficient magnitude to constitute a risk of electric shock to persons.



The exclamation point within an equilateral triangle is intended to alert the user to the presence of important operating and maintenance (servicing) instructions in the literature accompanying the appliance.

CAUTION

TO REDUCE THE RISK OF ELECTRIC SHOCK
DO NOT OPEN ENCLOSURE OR EXPOSE
TO RAIN OR MOISTURE.
NO USER-SERVICEABLE PARTS
INSIDE REFER SERVICING TO
QUALIFIED SERVICE PERSONNEL.

Contents

ALF-SMW42S.....	1
Introduction.....	4
Features	4
Package Contents	5
Panel Description.....	6
Front Panel.....	6
Rear Panel.....	7
Specifications.....	9
Installation and Wiring	11
Installation	11
Wiring	12
Key Function.....	14
AV over IP.....	14
Screen Layout Switch.....	14
Automatic Signal Switching	16
Screen Mirroring	17
(1) Screen Mirroring over Airplay.....	17
(2) Screen Mirroring over Miracast.....	18
(3) Screen Mirroring over USB Dongle (ALF-SMW42D)	23
Guide Screen.....	24
OSD.....	26
Web UI.....	28
General Tab	29
Device Name	29
Network	30
Access Code	30
Analog Audio Latency.....	31
Soft AP Password.....	32

Output.....	32
Sink Power Management.....	34
Password.....	35
Guide Screen Picture.....	36
Maintenance	36
Version Information.....	37
Video Source Tab	38
State & Switch	38
Manage Alias	39
Firmware Upgrade	40
Limited warranty in respect of Alfatron Products Only	41

Introduction

The ALF-SMW42S is a high-performance BYOD presentation switcher with wireless presentation capability. It equips a built-in Wi-Fi module and supports multiple access approaches, including Airplay Mirroring, Miracast, physical interfaces (HDMI, VGA and USB-C) and an USB Dongle, with which you can project screen contents of your computer (Mac/Windows) or mobile device (iPhone/iPad/Android) to a display in Multiview mode.

Multiple features like fast seamless switching, auto signal switch, serial control, CEC, Guide Screen, OSD display, USB switching and extension are included. The switcher is a collaboration terminal used for meeting room or workgroup discussion.

Features

- Multiview presentation with configurable screen layout.
- Built-in Wi-Fi module for wireless connectivity with devices over Airplay, Miracast, and USB Dongle.
- Fast seamless switching for both single view and Multiview.
- Supports HDMI input resolutions up to 4K@30Hz 4:4:4.
- Supports HDMI output resolutions up to 4K@60Hz 4:4:4.
- Detailed and friendly OSD information.
- Supports USB extension and switching control among three USB hosts.
- Offers multiple control approaches: front panel buttons, Web UI and Telnet API.
- Multiview layout adjustable by the end user.

Package Contents

- 1 x Switcher
- 1 x DC 12V Power Adapter (with US, EU, pins)
- 2 x Phoenix Male Connectors (3.5 mm, 4 Pins)
- 2 x Mounting Brackets (with Screws)
- 2 x Wi-Fi Antennas

Panel Description

Front Panel

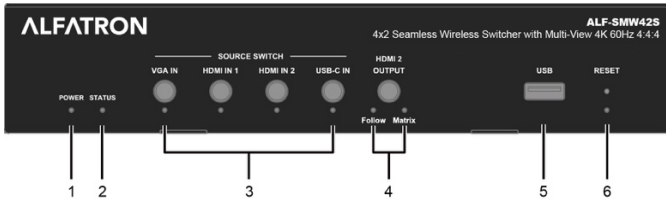

No.	Name	Description
1	Power LED	<ul style="list-style-type: none"> • On: The switcher is powered on. • Off: The switcher is powered off.
2	Status LED	<ul style="list-style-type: none"> • On: The switcher is outputting at least one video source. • Blinking: The switcher is in standby mode. • Off: The switcher is outputting Guide Screen.
3	Source Switch	<ul style="list-style-type: none"> • VGA IN ~ USB-C IN Buttons: <ul style="list-style-type: none"> ⇒ Short press to output or stop outputting the corresponding video source. ⇒ Hold press to output the corresponding video source in full screen mode. • VGA IN ~ USB-C IN LEDs: <ul style="list-style-type: none"> ⇒ On: The corresponding video signal is valid and is being output. ⇒ Blinking quickly: The corresponding video signal is valid but is not being output. ⇒ Blinking slowly: The corresponding video signal is being output but is not valid. ⇒ Off: The switcher is in standby mode. / The corresponding video signal is neither valid nor being output.
4	HDMI 2 Output	<ul style="list-style-type: none"> • HDMI2 Output button: press to switch between Follow mode and Matrix mode for HDMI Output 2. <ul style="list-style-type: none"> ⇒ To switch to Follow mode: long press the HDMI2 Output button until the Follow LED lights up. In Follow mode, HDMI OUT 2 follows HDMI OUT 1 to output the same video content as that of HDMI OUT 1. ⇒ To switch to Matrix mode: short press the HDMI 2 Output button. In Matrix mode, HDMI OUT 2 will

		<p>output a specific video source in single view (specified by Telnet API or Web UI); continue to short press the button, the HDMI OUT 2 will cycle through the hardware video sources (VGA > HDMI 1 > HDMI 2 > USB-C > VGA >...) for output.</p> <ul style="list-style-type: none"> LED Status: <ul style="list-style-type: none"> ⇒ Follow LED: Lights up when Follow mode is selected. ⇒ Matrix LED: Lights up when Matrix mode is selected.
5	USB	<ul style="list-style-type: none"> Connect to a U-disk for firmware upgrade. Connect to the USB Dongle for pairing up with each other.
6	Reset	Hold press this button for five or more seconds and then release, it will automatically reboot and restore to its factory defaults.

Rear Panel

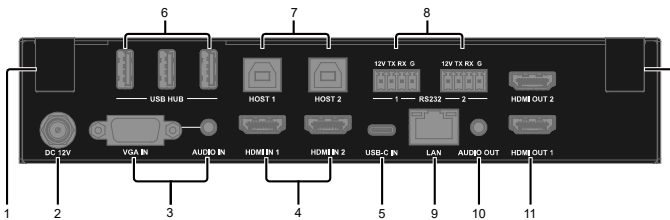

No.	Name	Description
1	Antenna	Connect to the antenna pair provided for the access to Miracast and soft AP function.
2	DC 12V	Connect to the power adapter provided.
3	VGA In	Connect to a VGA source for video input as well as analog audio input.
4	HDMI In 1-2	Connect to an HDMI source device.
5	USB-C In	Connect to a USB-C video source.
6	USB Hub	Connect to the USB device (e.g. mouse, keyboard, USB audio) for USB extension between USB device and USB host.
7	USB Host	Connect to USB host device for USB extension between USB device and USB host.
8	RS232 1-2	<ul style="list-style-type: none"> RS232-1: Reserved.

		<ul style="list-style-type: none">• RS232-2: Connect to a RS232-enabled device such as a projector to control the projector.<ul style="list-style-type: none">⇒ Pins TX, RX, GND are used to control the connected projector.⇒ Pins 12V, GND are used to provide 12VDC power.
9	LAN	Connect to a network device (e.g. network switch, router, computer, etc.) for LAN control (Web GUI & Telnet API) and Airplay Mirroring signal input.
10	Audio Out	Connect to an audio receiver (e.g. amplifier) for audio output.
11	HDMI Out 1-2	Connect to an HDMI display device.

Specifications

Technical	
Input Video Port	1 x VGA; 2 x HDMI; 1 x USB-C; 1 x LAN, 10/100/1000 Mbps Ethernet; 1 x WLAN
Input Resolutions	<ul style="list-style-type: none"> VGA: 640x480^{8,9}, 720x480⁸, 720x576⁶, 800x600⁸, 1024x768^{8,9}, 1280x720^{7,8}, 1280x800⁸, 1280x1024^{8,9}, 1360x768⁸, 1366x768⁸, 1400x1050⁸, 1440x900⁸, 1600x900⁸, 1600x1200^{8,9}, 1920x1080^{6,8} HDMI/USB-C: 640x480⁸, 800x600⁸, 1024x768⁸, 1280x768⁸, 1280x800⁸, 1280x1024⁸, 1360x768⁸, 1366x768⁸, 1440x900⁸, 1400x1050⁸, 1600x1200⁸, 1680x1050⁸, 1920x1200⁸, 720x480⁸ (480p), 720x576⁶ (576p), 1280x720⁵ (720p30), 1280x720⁵ (720p50), 1280x720³ (720p60), 1920x1080² (1080p24), 1920x1080³ (1080p25), 1920x1080⁵ (1080p30), 1920x1080⁶ (1080p50), 1920x1080⁸ (1080p60), 3840x2160⁵(2160p30) LAN/WLAN: Up to 1920x1080⁸ (1080p60) Note: The input resolution support for LAN or WLAN may vary according to the specific BYOD protocols and devices. 1 = at 23.98 Hz, 2 = at 24 Hz, 3 = at 25 Hz, 4 = at 29.97 Hz, 5 = at 30 Hz, 6 = at 50 Hz, 7 = at 59.94 Hz, 8 = 60 Hz, 9 = 75 Hz
Output Video Port	2 x HDMI, 1x Ethernet port (AV over IP)
Output Resolutions	For HDMI OUT 1: 720x480 ⁸ (480p60), 720x576 ⁶ (576p60), 640x480 ⁸ , 800x600 ⁸ , 1024x768 ⁸ , 1280x1024 ⁸ , 1366x768 ⁸ , 1440x900 ⁸ , 1280x800 ⁸ , 1680x1050 ⁸ , 1920x2160 ⁵ , 1600x1200 ⁸ , 1920x1200 ⁸ , 2560x1440 ⁵ , 2560x1440 ⁸ , 1280x720 ⁵ (720p50), 1280x720 ³ (720p60), 1920x1080 ⁵ (1080i50), 1920x1080 ⁸ (1080i60), 1920x1080 ² (1080p24), 1920x1080 ³ (1080p25), 1920x1080 ⁵ (1080p30) , 1920x1080 ⁶ (1080p50), 1920x1080 ⁸ (1080p60), 3840x2160 ² (2160p24) , 3840x2160 ³ (2160p25) , 3840x2160 ⁵ (2160p30) ,

	<p>3840x2160⁶ (2160p50) , 3840x2160⁸ (2160p60)</p> <p>For HDMI OUT 2: Up to 1920x1080⁸ (1080p60)</p> <p>1 = at 23.98 Hz, 2 = at 24 Hz, 3 = at 25 Hz, 4 = at 29.97 Hz, 5 = at 30 Hz, 6 = at 50 Hz, 7 = at 59.94 Hz, 8 = 60 Hz, 9 = 75 Hz</p> <p>For AV Over IP Up to 1920x1080⁸ (1080p60)</p> <p>1 = at 23.98 Hz, 2 = at 24 Hz, 3 = at 25 Hz, 4 = at 29.97 Hz, 5 = at 30 Hz, 6 = at 50 Hz, 7 = at 59.94 Hz, 8 = 60 Hz</p>
Input Audio Port	2 x HDMI, 1 x USB-C, 1 x LAN, 1 x Analog Audio, 1 x WLAN
Input Audio Format	RAW PCM, 16 bit, 32/44.1/48KHz sps; PCM 2.0
Output Audio Port	2 x HDMI, 1 x Analog Audio
Output Audio Format	RAW PCM, 16 bit, 32/44.1/48KHz sps; PCM 2.0
Control Method	Front panel buttons; Web UI; Telnet API/CLI

Wi-Fi	
Standard	IEEE 802.11 a/b/g/n/ac
Frequency	Dual bands, 2.4~2.4835GHz, 5.0~5.8GHz
Throughput	2T x 2R, up to 867Mbps
Security	WEP, TKIP, AES, WPA, WPA2

General	
Operating Temperature	0°C to 45°C (32°F to 113°F)
Storage Temperature	-20°C to 70°C (-4°F to 158°F)
Humidity	10% to 90%, non-condensing
ESD Protection	Human-body Model: ±8kV (Air-gap discharge)/ ±4kV (Contact discharge)
Power Supply	12 V 1 A DC
Power Consumption	20W (Max)
Device Dimension (W x H x D)	215 mm x 42 mm x 140.2 mm / 8.46" x 1.65" x 5.52"
Net Weight	1.0kg/2.2lbs

Installation and Wiring

Installation

Note:

- Before installation, please ensure the switcher is disconnected from the power source.
- It is recommended that you remove other WiFi hotspot devices nearby (if any) so to prevent potential interferences on screen projection.

Attaching Antennas

1. Attach the antenna provided to the threaded connector and screw it into place rotating clockwise.

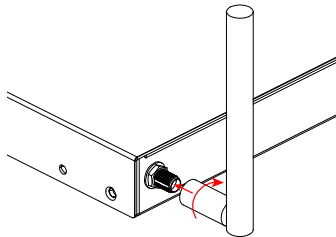

2. Repeat the above step for another antenna.

Attaching Installation Brackets

1. Attach the installation bracket to the enclosure using the screws provided in the package separately.
2. The bracket is attached to the enclosure as shown.

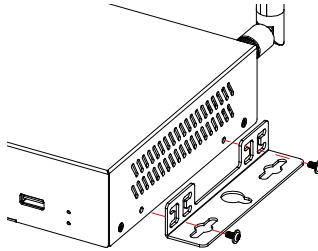

3. Repeat steps 1-2 for the other side of the switcher.
4. Attach the brackets to the surface you want to hold the switcher against using screws (provided by others).

Wiring

Warnings:

- Before wiring, disconnect the power from all devices.
- During wiring, connect and disconnect the cables gently.

See below application diagram:

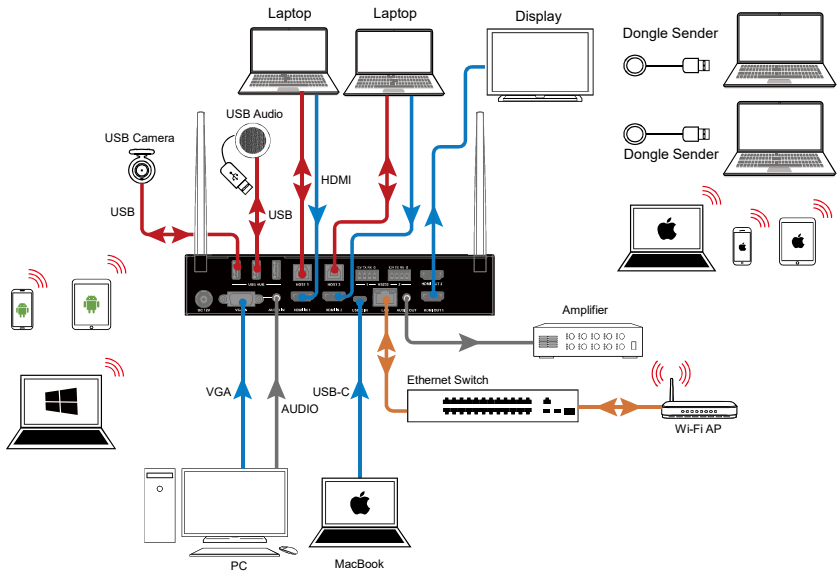

Note:

- If you connect the switcher to an Ethernet Switch, please ensure the switch is able to forward messages from the 224.0.0.251 multicast group. Most non-managed switches meet this requirement.
- If a managed switch is to be used, you must contact the network administrator or switch supplier to ensure the above requirement is met, and consider adjusting the switch configuration if necessary.

Key Function

AV over IP

Application

In the following application:

- The switcher works with ALF-IP2HD decoders through an Ethernet switch to build a flexible distributed presentation system, achieving point-to-point and point-to-multipoint applications.
- Once the ALF-IP2HD decoders are connected to the system, they pair up with the switcher automatically and output picture, no additional operation is required.

Screen Layout Switch

The switcher supports automatic/manual switching on Multiview screen layout, i.e. multiple video sources can be displayed in Multiview form on a single screen.

By default, the screen layout switching mode is set as automatic switching for the switcher, and the preset screen layouts allows for up to sixteen video sources to be displayed on a screen as the following:

**Note:**

- As the video sources to be displayed increase or decrease, the switcher will automatically change to a new screen layout so that all video sources can be displayed appropriately on the whole screen.
- As the video sources increase up until there's no available screen layout that allows for all these sources to be displayed on the screen, when a new video source inputs:
 - 1) The source that displays on the screen for the longest will be replaced by the latest input source;
 - 2) The latest input source will display on the main window* of the screen. (*By default, the main window lies in the upper left of the screen.)

The switcher also offers manual switching on the screen layout, which allows you to customize Multiview screen layout (up to 16 views), switching sequence and main window. For more information, please see the separate API documentation.

Automatic Signal Switching

Automatic signal switching function allows you to easily and quickly output desired sources. By default, automatic signal switching function is set as enabled.

1. When a video source inputs, the switcher will automatically output and display it on the screen.
2. When a new video source inputs in the case that there's no available screen layout for all these video sources to be displayed, the switcher will have this new video source displayed on the screen's main window and remove the video that displays on screen for the longest.
3. As the video sources increase or decrease, the switcher will change to a new screen layout automatically so that all video sources can be displayed appropriately on the whole screen.
4. If all video sources are removed, the switcher will output the Guide Screen picture.

The switcher also offers three methods of switching to specific video source manually:

- 1) Using the front panel buttons to output corresponding hardware video source.
- 2) Using web UI.
- 3) Using API commands. For more information please see the separate API documentation.

Screen Mirroring

With screen mirroring support, the switcher allows users to wirelessly share multimedia from their devices on any HDMI displays. The switcher allows users to perform screen mirroring over Airplay Mirroring and Miracast.

(1) Screen Mirroring over Airplay

Take iPhone 8 (iOS 13.1) for example:

1. Connect your iPhone to the soft AP of the switcher.
 - ⇒ **Soft AP SSID:** same as switcher's device name and can be obtained from OSD at the upper right of the display screen; by default, it is set as SMW42S.
 - ⇒ **Password:** set through Web GUI or API and can be obtained from OSD at the bottom right of the display screen; by default, it is set as **12345678**.
2. Slide up from the bottom of the iPhone's screen to show the control center. Click **Screen Mirroring** and choose the device name in the pop-up list. The display will output the screen of iPhone.

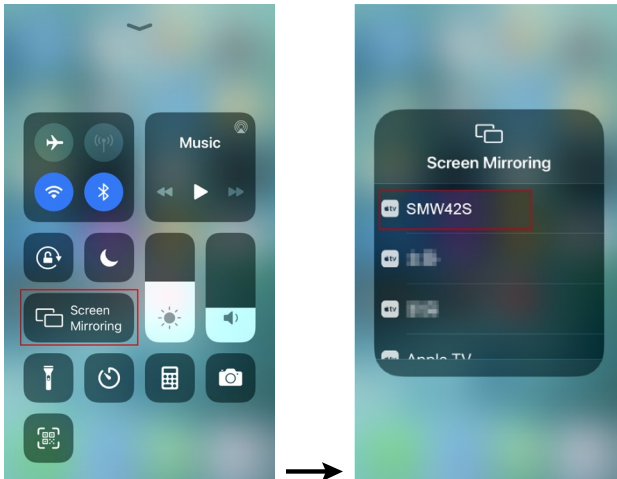

3. To disconnect iPhone from the switcher: click **Stop Mirroring**, the

display will stop outputting the screen of iPhone.

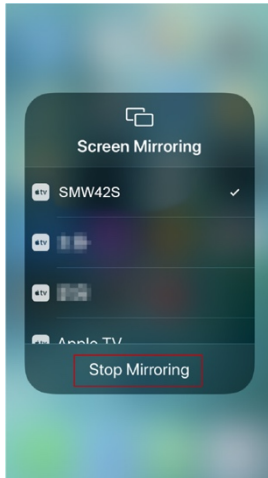

(2) Screen Mirroring over Miracast

For Android mobile (take Samsung Galaxy S9 for example):

1. Enable the Wi-Fi or WLAN feature of the mobile.
2. Slide down from the top of the screen and click the **Smart View** icon in the pop-up interface.

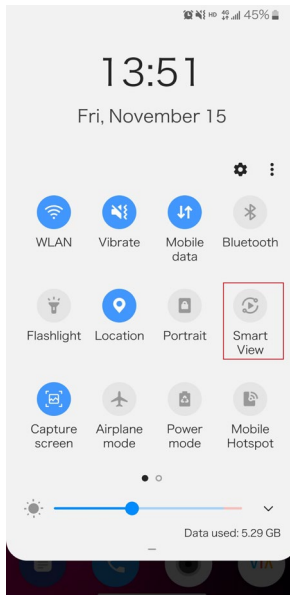

3. The Smart View window will appear and start to search Miracast receiver. Click the device name in the search result, the display will output the mobile' screen.

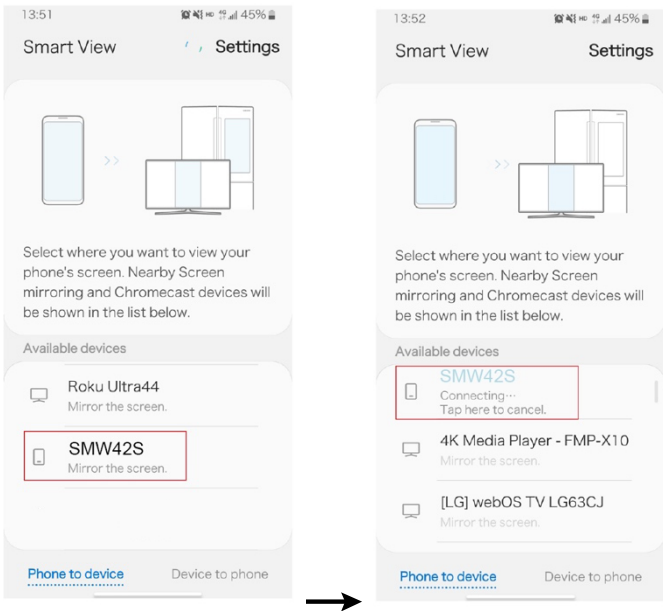

4. To disconnect mobile from the switcher: click the icon  on the mobile screen and choose **Disconnect** in the Smart View window.

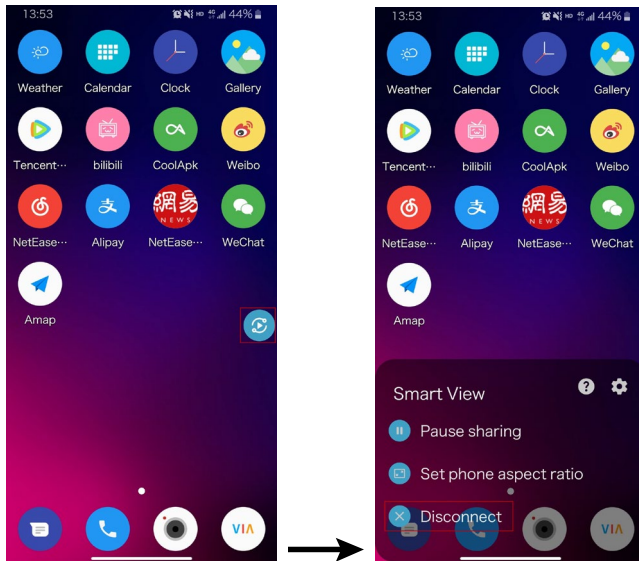
**Note:**

- The icon, instruction and entrance of the Miracast function may vary on different Android mobile phones, please refer to your mobile phone's manual to get accurate instruction.
- If you fail to use Miracast function, please disable the mobile's Wi-Fi and enable it later, or restart the mobile if necessary.

For Windows 10 PC:

1. Enable the WLAN feature of your PC.
2. Click the icon on bottom right of the screen to open **Action Center**.

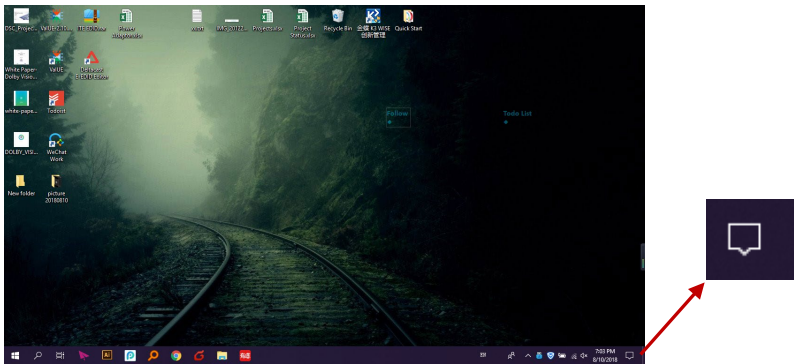

3. Click **Connect**.

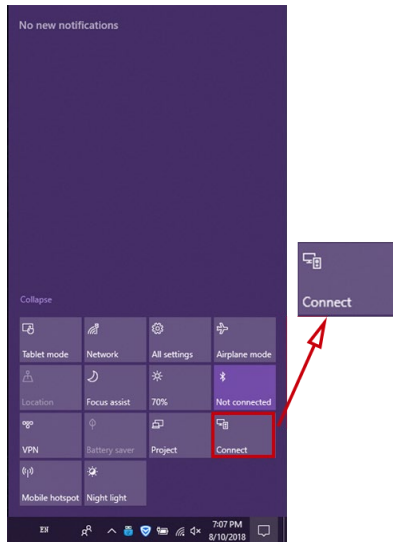

4. Click the switcher's device name in the search result.

5. To disconnect PC from the switcher: click **Disconnect**, the display will stop outputting the PC's screen.

Note:

- The icon and interface of the Miracast feature may vary on different computers.

- Some Windows 10 computers may fail to perform screen mirroring over Miracast due to compatibility issues.

Tip: Both the Airplay mirroring and Miracast support access code. If you see the PIN entry window appears on your devices, input the access code that can be obtained through OSD. (See “OSD” section for more information.)

(3) Screen Mirroring over USB Dongle (ALF-SMW42D)

USB Dongle allows you to share content from your laptop on the display screen in a simple way – just by clicking the button of the USB Dongle connected to the laptop without installing any additional software.

Introduction to USB Dongle



No.	Name	Description
1	USB port	Connect to the switcher or laptop for pairing up or projecting screen.
2	LED Indicator	<p>Blinking:</p> <ul style="list-style-type: none"> ⇒ When connected to the switcher: USB Dongle is being pairing up with the switcher. ⇒ When connected to the computer: USB Dongle is starting or is establishing connection with the switcher. <p>Solid on:</p> <ul style="list-style-type: none"> ⇒ When connected to the switcher: USB Dongle is paired up with the switcher successfully. ⇒ When connected to the computer: USB Dongle is

		connected to the switcher successfully. You can press the button to start for screen projection now.
3	Projection Button	Press the button to project laptop's screen on the display.

Note: USB Dongle is sold separately.

Steps to share laptop's screen on the display using USB dongle:

1. Pair USB Dongle with the switcher.
Connect USB Dongle to USB Type A of the switcher for pairing up. Then the switcher will set its soft AP's SSID and password for USB dongle. Once pairing is done, "Pairing succeeded" will appear on the display screen.
2. Connect USB Dongle to a laptop.
Connect USB Dongle to the laptop, it will start running and connecting to the switcher's soft AP. Once the Dongle connects to the switcher successfully, the USB Dongle LED stops blinking and turns to be solid on.
3. Now press the USB Dongle button, you can share your laptop's screen on the display screen immediately. Hold press the button for at least 5 seconds, you can have your laptop's screen displayed in full screen.

Guide Screen

The switcher uses a Guide Screen to convey the basic connection instructions for user access. The Guide Screen can be personalized to allow custom connection instructions on the switcher's Web UI page.

The Guide Screen is accessible in the following cases:

- Automatic switching: disconnect all video sources from the switcher, the Guide Screen will appear automatically.
- Manual switching:
 - 1) Short press the source selection button on front panel until no active

video sources are displayed.

2) Send API command through telnet to the switcher to show the Guide Screen. For more information, please see the separate API documentation.

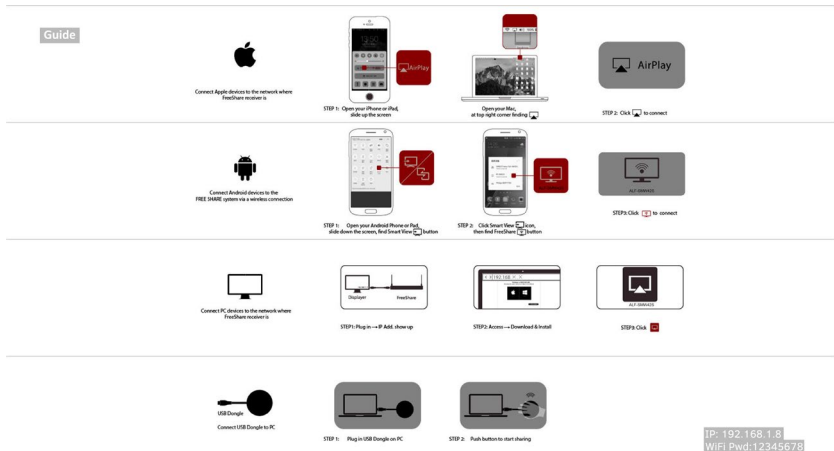

Note:

- This Guide Screen picture can be changed through Web GUI setting, please refer to section [Guide Screen Picture](#) for more information.
- By default, if Guide Screen picture is being output for 60 seconds, a countdown timer with the time period of 60 seconds will appear on the Guide Screen. When the timer ticks to zero, if the connected display is CEC-supported or correctly set with RS232 control commands, it will enter standby mode.

OSD

The switcher supports OSD (On Screen Display) to convey device basic information, including video source's information, access code, device name and IP address, etc. Here are two different OSD examples in different scenarios.

Example 1: Full screen mode

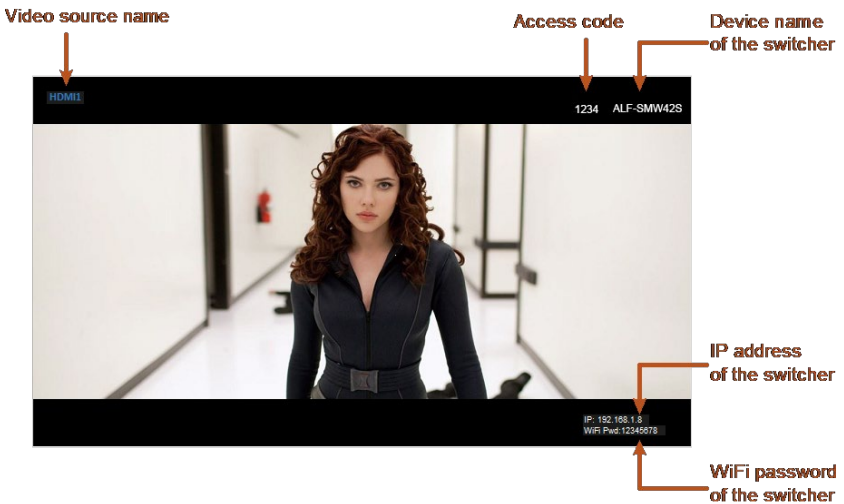

Example 2: Multiview mode

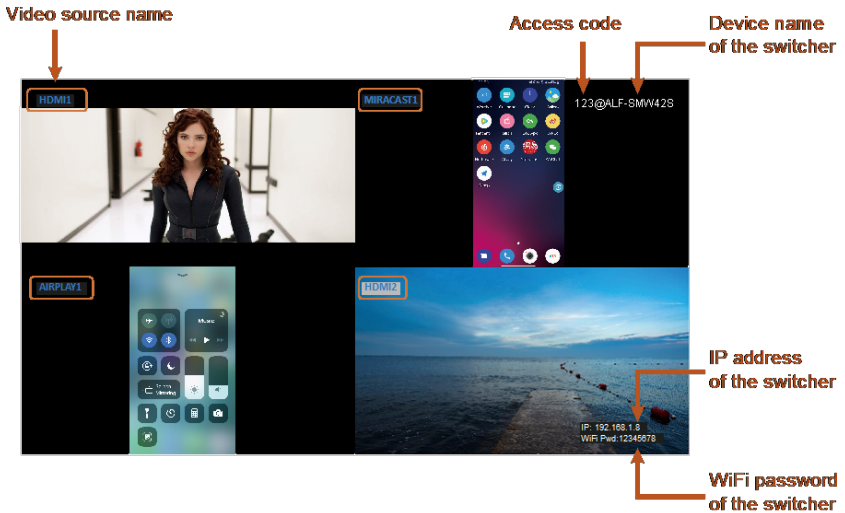

Note:

- When the switcher outputs Guide Screen picture, the OSD will display all the time.
- When the switcher outputs specific video sources, the OSD will display on the display device's screen for 10 seconds and then disappear.
- By default, the access code is set as blank, therefore the OSD doesn't display the access code. If you want to set access code, please refer to [Access Code](#) section for more information.

Web UI

The Web UI provides basic controls and advanced settings. It can be accessed through an internet browser, e.g. Chrome, Safari, Firefox, IE10+, etc.

By default, the switcher comes with a default IP address **192.168.1.8**. Subnet mask is **255.255.255.0**.

To get access to Web UI:

1. Connect your PC and the LAN port of the switcher to a local area network.
2. Set your PC to the same network segment as the switcher, e.g. 192.168.1.xxx.
3. Input the switcher's IP address in the browser and press Enter and the following window will pop up.

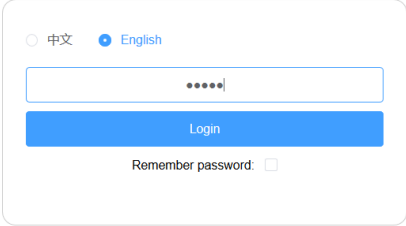

The image shows a login form for the Web UI. At the top, there are two radio buttons for language selection: '中文' (Chinese) and 'English'. The 'English' option is selected. Below the language selection is a password input field with a blue border and a blue outline. The password is masked with six dots. Below the password field is a blue 'Login' button. At the bottom, there is a 'Remember password:' label followed by an unchecked checkbox.

4. Choose the language you wish to use: English or Chinese.
5. Input password (default password: admin) and click Login to enter the main page of Web UI.

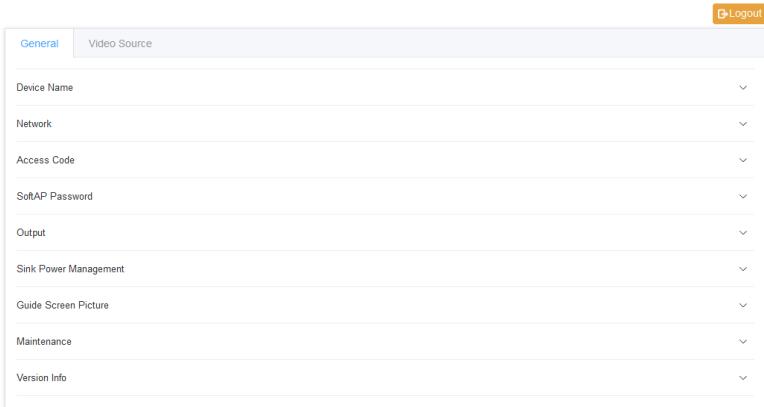

The Web UI main page consists of General and Video Source Tabs.

General Tab

Device Name

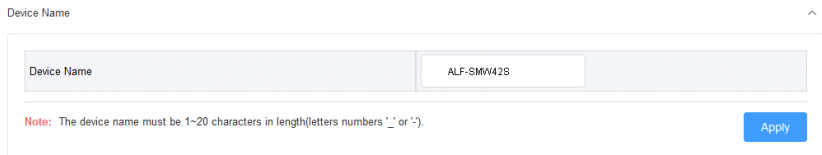

UI Element	Description
Device Name	Redefine the device name to names easy to remember. Note: The name must be 1~20 characters in length, including letters, numbers, “_” or “-”. By default, it’s set as SMW42S.
Apply	Click to perform current settings.

Network

Network

IP Mode	Static
IP Address	192.168.1.8
Netmask	255.255.255.0
Gateway	192.168.1.1
DNS Server 1	
DNS Server 2	

Note: After changing network configuration, please reopen the web page with the new network settings.

Apply

UI Element	Description
Network	For network settings in the switcher’s LAN port.
IP Mode	Select an IP mode from DHCP and Static. By default, it’s set as Static .
IP Address	Set IP address manually for the switcher when Static mode is selected.
Netmask	Set subnet mask manually for the switcher when Static mode is selected.
Gateway	Set gateway address manually for the switcher to communicate with another network that uses different communication protocols when Static mode is selected.
DNS Server 1	Set DNS server manually for the switcher to ensure normal network communication.
DNS Server 2	
Apply	Click to save and perform current settings. Note: After changing the IP settings, please refresh the Web UI page to re-login.

Access Code

Access Code

Access Code	(0000 ~ 9999 or blank) <input type="checkbox"/> Auto
-------------	--

Refresh Apply

UI Element	Description
Access Code	<p>Enter a four-digit access code to help prevent users from accidentally connecting to an unintended device and protect from an unauthorized access.</p> <ul style="list-style-type: none"> When an access code is configured, it appears on the upper right corner of the display. If you don't want to set access code, you can enter nothing here. <p>By default, it's set as blank.</p>
Auto	<p>When "Auto" is checked, the switcher will randomly generate a four-digit access code in the following cases:</p> <ul style="list-style-type: none"> The switcher switches to Guide Screen for output. The switcher reboots.
Refresh	Click to refresh to the latest access code.
Apply	Click to perform current settings.

Analog Audio Latency

Analog Audio Latency

UI Element	Description
Analog Audio Latency	<p>Input a digit to set the latency time for analog audio signal output.</p> <p>By default, it's set as zero.</p> <p>Note: The digit should be within the range from 0 to 200 and must be an integer multiple of 20.</p>
Apply	Click to perform current settings.

Soft AP Password

SoftAP Password ^

Password

12345678

Note: Softap password must be 8~20 characters, or blank.

Apply

UI Element	Description
Password	Set soft AP password. Note: <ul style="list-style-type: none"> The soft AP SSID is as same as the Device Name of SMW42S. (Default Device Name is SMW42S) The soft AP password must be 8 to 20 characters in length. If you don't want to set password, you can leave it blank here.
Apply	Click to perform current settings.

Output

Output ^

Output timing

3840x2160P@30

Auto

Refresh
Apply

Output HDCP Support

Enable

Apply

Auto StandBy (Minute, ranges from 0 to 60, set to 0 for deactivation)

1

Apply

UI Element	Description
Output Timing	<p>Set the output timing for the HDMI output ports. Two operation methods are offered in the following:</p> <ul style="list-style-type: none"> • Auto: select to output the maximum resolution supported by display based on the display's EDID. E.g. If display supports up to 4K@60Hz, the switcher will output 4K@60Hz. • Resolution range list: select a desired output resolution from the dropdown menu to output this fixed resolution. <p>By default, it's set as Auto.</p>
Refresh	<p>Click to refresh the latest status of the output timing.</p>
Output HDCP Support	<p>Set the HDCP capability for the HDMI output. Two options are offered in the following:</p> <ul style="list-style-type: none"> • Enable: select to enable HDCP capability of the output. • Disable: select to disable HDCP capability of the output. <p>By default, it's set as Enable.</p>
Auto Standby (0~60 minutes)	<p>Set a period of time that remains before the countdown timer begins for auto standby.</p> <ul style="list-style-type: none"> • For example, when the current input is Guide Screen, 1 minute means if there's no signal present at the display in 1 minute, the countdown timer for display standby begins; when the timer ticks to zero, the display enters standby mode. Note: If the connected display doesn't support CEC or isn't correctly set with RS232 commands, the word "Standby" appears in the middle of the Guide Screen. • If it's set to 0 minute, it means this function is disabled, you cannot set the display to standby mode. <p>By default, auto standby is set as 1 minute.</p>
Apply	<p>Click to perform current settings.</p>

Sink Power Management

Sink Power Management

Sink Power Mode	Both	
Interval between two consecutive commands to the sink(Second, ranges from 0 to 200)	8	
RS232 parameter	9600-8n1	example: 115200-8n1
RS232 standby command		
RS232 wakeup command		
RS232 hex string enable	Disable	

Power On Power Off Apply

UI Element	Description															
Sink Power Management	Set display to enter standby mode or to return to their normal working state through CEC capability or RS232 commands.															
Sink Power Mode	<ul style="list-style-type: none"> both: Enable both CEC and RS232 mode to manage the sink power. cec: Enable CEC to manage the sink power. rs232: Enable RS232 to manage the sink power. By default, it's set as both .															
Interval between two consecutive commands to the sink (Second)	Specify a time interval between sending two consecutive commands to the sink (in seconds). The interval should not be less than 0s. Note : If you're not clear about this function, it's suggested that you make no changes here or contact the manufacturer. By default, the interval is set as 8 seconds.															
RS232 Parameter	Set the RS232 parameters for the controlled display. For more information about the parameters, see the user guide of your display devices. <table border="1" style="margin-top: 10px;"> <thead> <tr> <th>Parameter</th> <th>Value</th> <th>Abbreviation</th> </tr> </thead> <tbody> <tr> <td>Baud Rate</td> <td>9600bps</td> <td>9600</td> </tr> <tr> <td>Data Bits</td> <td>8bits</td> <td>8</td> </tr> <tr> <td>Parity</td> <td>None</td> <td>n</td> </tr> <tr> <td>Stop Bits</td> <td>1</td> <td>1</td> </tr> </tbody> </table>	Parameter	Value	Abbreviation	Baud Rate	9600bps	9600	Data Bits	8bits	8	Parity	None	n	Stop Bits	1	1
Parameter	Value	Abbreviation														
Baud Rate	9600bps	9600														
Data Bits	8bits	8														
Parity	None	n														
Stop Bits	1	1														

	By default, its set as 9600-8n1 .
RS232 standby command	Enter the RS232 standby command of a controlled display device. For more information about the command, see the user guide of your display devices. If you want to disable this function, you can enter nothing here. By default, it's set as blank.
RS232 wakeup command	Enter the RS232 wakeup command of a controlled display device. For more information about the command, see the user guide of your display devices. If you want to disable this function, you can enter nothing here. By default, it's set as blank.
RS232 hex string enable	<ul style="list-style-type: none"> • Enable: select to use the hex numbers of RS232 standby and wakeup commands to control your display devices. If this is the case, make sure standby and wakeup commands are manually converted to their equivalent hex representations first and then input in RS232 standby command and RS232 wakeup command. For example, RS232 wake up command in hex may be: <i>50 57 52 20 4F 4E 0D 0A</i>. • Disable: select to directly send the original standby or wakeup commands to control display devices. By default, it's set as Disable .
Power On	Click to power on the connected display.
Power Off	Click to power off the connected display.
Apply	Click to perform current settings.

Password

Password

New Password

Note: Password must be 4 to 16 characters in length, alphanumeric only.

UI Element	Description
Password	Set a new login password for the switcher. Note: The new password must be 4 to 16 characters in length, alphanumeric only.
Apply	Click to perform current settings.

Guide Screen Picture

Guide Screen Picture

File:

Note: You must upload an image in jp(e)g format that has 1920 x 1080 pixels.

UI Element	Description
Browse	For changing a picture for Guide Screen.
Apply	Click to upload the picture file to the switcher. Note: The picture must be in jp(e)g format that has 1920 x 1080 pixels.

Maintenance

Maintenance

Upgrade

File:

Note: The legal firmware package is a .zip archive. The system will be rebooted to finish upgrading.

UI Element	Description
Browse	Click to browse for the local upgrade file and upload for firmware upgrade. Note: The legal firmware package is a .zip archive.
Apply	Click to perform firmware upgrade.
Reboot	Click to restart the switcher.

Reset to Factory Default	Click to restore the switcher to its factory defaults. You can also perform this task by using the RESET button on front panel.
--------------------------	---

Steps to upgrade firmware:

1. Click **Browse** to select the upgrade file on the computer and upload it to the switcher for firmware upgrade. It will take a few seconds to upload the upgrade file.
2. The following window will appear once the upload is completed. Then the switcher will reboot. Please refresh the page and then re-login.

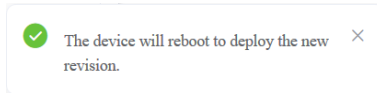

Version Information

Version Info

Version	V1.4.5
Build Time	2020.02.28 09:39:26

UI Element	Description
Version Info	Displays the switcher's firmware information.
Version	Shows the switcher's firmware version.
Build Time	Shows the time and date when the switcher's firmware was built.

Video Source Tab

State & Switch

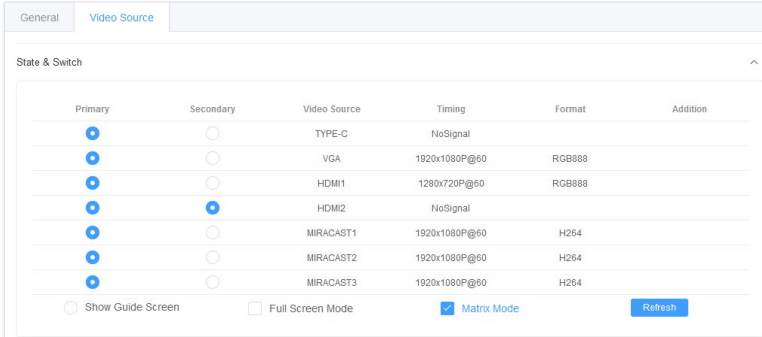

UI Element	Description
State & Switch	For displaying the video signal status (including video source name, video resolution and video format) and setting the display mode.
Primary	Click the button (turns from white to blue) to display the video source(s) on the screen connected to HDMI Out 1.
Secondary	Click the button (turns from white to blue) to display the video source(s) on the screen connected to HDMI Out 2.
Show Guide Screen	Click the button (turns from white to blue) to display Guide Screen on the screen connected to HDMI OUT 1 and HDMI OUT 2.
Full Screen Mode	Check the box to display the selected video source in full screen mode on the screen connected to HDMI Out 1.
Matrix Mode	<ul style="list-style-type: none"> When the box is checked, the screen connected to HDMI Out 2 will display the selected video source (in Secondary column) in single view. When the box is not checked, the screen connected to HDMI Out 2 will display the same video content as that of HDMI OUT 1.
Refresh	Click to refresh to the current state information.

Manage Alias

Manage Alias

The screenshot shows a settings window titled 'Manage Alias'. It contains two main input fields: 'Video Source' and 'Alias'. The 'Video Source' field has a dropdown menu with four options: 'TYPE-C', 'VGA', 'HDMI1', and 'HDMI2'. Below these fields are two blue buttons: 'Restore' and 'Apply'.

UI Element	Description
Video Source	Displays the video source name.
Alias	Enter an alias to change the video source name to a new one.
Restore	Click to restore the setting to factory defaults.
Apply	Click to perform the current settings.

Firmware Upgrade

ALF-SMW42S supports firmware upgrade through Web UI and USB ports on the front panel.

To upgrade firmware through Web UI, see [Maintenance](#) section.

To upgrade firmware through USB port on the front panel, perform the following:

1. Name the upgrade file package “MS330-update.zip”.
2. Create a new folder named “upgrade” under the root directory of a FAT32 or NTFS Udisk. Place the upgrade file in this folder.

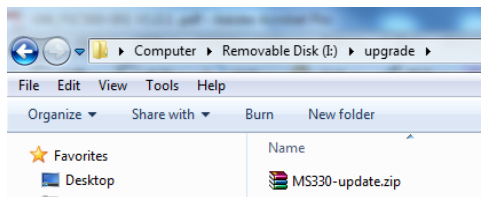

3. Connect the Udisk to the switcher’s USB port. It takes about 1 minute for the switcher to read the Udisk. If the switcher detects the upgrade file is a newer version, it will start to upgrade, and the LED indicators on front panel -- VGA, HDMI 1-2 & USB-C LEDs will start blinking. When the upgrade process is completed, the four LEDs will stop blinking and return to normal state.

Note:

- Do not cut off power during the upgrade process.
- If the switcher detects the upgrade file is not a newer version, it will not start upgrade.
- If you want to perform force upgrade¹, add the forcedeploy file to the “upgrade” folder. The switcher will start to upgrade whether the version of upgrade file is newer or not. Therefore, please use this method with caution.

¹ The mechanism of force upgrade is that the switcher starts upgrade only if it detects the presence of forcedeploy file. The file’s format, content or size doesn’t affect the detection.

Limited warranty in respect of Alfatron Products Only

1.1 This limited warranty covers defects in materials and workmanship in this product.

1.2 Should warranty service be required, proof of purchase must be presented to the Company. The serial number on the product must be clearly visible and not have been tampered with in any way whatsoever.

1.3 This limited warranty does not cover any damage, deterioration or malfunction resulting from any alteration, modification, improper or unreasonable use or maintenance, misuse, abuse, accident, neglect, exposure to excess moisture, fire, improper packing and shipping (such claims must be presented to the carrier), lightning, power surges, or other acts of nature. This limited warranty does not cover any damage, deterioration or malfunction resulting from the installation or removal of this product from any installation, any unauthorized tampering with this product, any repairs attempted by anyone unauthorized by the Company to make such repairs, or any other cause which does not relate directly to a defect in materials and/or workmanship of this product. This limited warranty does not cover equipment enclosures, cables or accessories used in conjunction with this product.

This limited warranty does not cover the cost of normal maintenance. Failure of the product due to insufficient or improper maintenance is not covered.

1.4 The Company does not warrant that the product covered hereby, including, without limitation, the technology and/or integrated circuit(s) included in the product, will not become obsolete or that such items are or will remain compatible with any other product or technology with which the product may be used.

1.5 Only the original purchaser of this product is covered under this limited warranty. This limited warranty is not transferable to subsequent purchasers or owners of this product.

1.6 Unless otherwise specified, the goods are warranted in accordance with the manufacturer's product specific warranties against any defect attributable to faulty workmanship or materials, fair wear and tear being excluded.

1.7 This limited warranty only covers the cost of faulty goods and does not include the cost of labor and travel to return the goods to the Company's premises.

1.8 In the event of any improper maintenance, repair or service being carried out by any third persons during the warranty period without the Company's written authorization, the limited warranty shall be void.

1.9 A 7 (seven) year limited warranty is given on the aforesaid product where used correctly according to the Company's instructions, and only with the use of the Company's components.

1.10 The Company will, at its sole option, provide one of the following three remedies to whatever extent it shall deem necessary to satisfy a proper claim under this limited warranty:

1.10.1 Elect to repair or facilitate the repair of any defective parts within a reasonable period of time, free of any charge for the necessary parts and labor to complete the repair and restore this product to its proper operating condition.; or

1.10.2 Replace this product with a direct replacement or with a similar product deemed by the Company to perform substantially the same function as the original product; or

1.10.3 Issue a refund of the original purchase price less depreciation to be determined based on the age of the product at the time remedy is sought under this limited warranty.

1.11 The Company is not obligated to provide the Customer with a substitute unit during the limited warranty period or at any time thereafter.

1.12 If this product is returned to the Company this product must be insured during shipment, with the insurance and shipping charges prepaid by the Customer. If this product is returned uninsured, the Customer assumes all risks of loss or damage during shipment. The Company will not be responsible for any costs related to the removal or re-installation of this product from or into any installation. The Company will not be responsible for any costs related to any setting up this product, any adjustment of user controls or any programming required for a specific installation of this product.

1.13 Please be aware that the Company's products and components have not been tested with competitor's products and therefore the Company cannot warrant products and/or components used in conjunction with competitor's products.

1.14 The appropriateness of the goods for the purpose intended is only warranted to the extent that the goods are used in accordance with the Company's installation, classification, and usage instructions.

1.15 Any claim by the Customer which is based on any defect in the quality or condition of the goods or their failure to correspond with specification shall be notified in writing to the Company within 7 days of delivery or (where the defect or failure was not apparent on reasonable inspection by the Customer) within a reasonable time after discovery of the defect or failure, but, in any event, within 6 months of delivery.

1.16 If delivery is not refused, and the Customer does not notify the Company accordingly, the Customer may not reject the goods and the Company shall have no liability and the Customer shall pay the price as if the goods had been delivered in accordance with the Agreement.

1.17 THE MAXIMUM LIABILITY OF THE COMPANY UNDER THIS LIMITED WARRANTY SHALL NOT EXCEED THE ACTUAL PURCHASE PRICE PAID FOR THE PRODUCT